

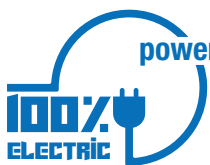

ELION



THINK URBAN. DRIVE ELECTRIC.



powered by



ECO POWER GROUP

www.elion.net



T
SERIE

ELION **T** RANSPORT - THE ELECTRIC TRANSPORTER

The ELION T-series from the manufacturer MUP technologies GmbH (first and only OEM for the manufacture of electric commercial vehicles) from Austria, is a fully electric transporter

in the vehicle class N1 up to 3.5 tons. MUP technologies is the specialist for electric utility vehicles & equipment carriers for municipal services & urban use.

MUP technologies' vehicles are perfectly suited to match modern and innovative municipalities

that intend to work in an exemplary, emission-free and nearly noiseless manner in environmental zones. For this application, MUP technologies offers a complete digitalization

of your vehicle, whether in combination with a fleet management or MUP technologies' own Databox. Document and optimize your daily operations with a mouse-click.

You can also benefit from the modular vehicle concept of the T series for maximum future security. Additional attachments and superstructures can also be easily and conveniently

exchanged or retrofitted at a later date.

The designs of ELION vehicles are also characterized by low follow-up costs in maintenance

and operation, by the use of high-quality assemblies and partly maintenance-free components such as engines. Benefit from the simple diagnostic options of the vehicles, or the low operating costs of around 1/5 of a conventional vehicle in the same vehicle class with an internal combustion engine.

SAVE TIME!

Improve the efficiency of your fleet with the T-series transporters and a design speed of 67 km/h. Shorten the travel time to your work sites, or use the option to drive on the city highway.





EMISSION-FREE PRODUCTION

As manufacturer, MUP technologies aims to keep the CO₂-emissions in Stallhofen/Austria as low as possible. The energy supply of the entire production site is completely ensured by renewable energies. In this way the vehicles already leave behind a very small ecological footprint during production.

MUP TECHNOLOGIES' VEHICLES ARE 100 % ELECTRICALLY POWERED.

All ELION attachments and superstructures have been specially designed, developed and optimized for electrified operation.

COST COMPARISON ELION T20 TO COMBUSTION WITH DIESEL ENGINE:

The ELION T20 requires around 13.5 kWh per 100 km at an average speed of 35 km/h.

In comparison, a combustion engine of the same vehicle class and similar design powered by diesel requires around 112.7 kWh per 100km.

¹⁾Data: Vehicle MUP technologies, 33 kW, all-wheel drive, approx. 135 Wh/km at 35 km/h (average), combustion engine 33 kW diesel, approx. 1,127 Wh/km, at 35 km/h (average). Thus cost (energy consumption) ELION T20 on 100 km (electricity cost average Eurostat 2019 = 0,2294 €/kWh) about 3,09 €/ 100 km.



From
1) 3,09€ /100km
0g HC-Emission
0g CO₂-Emission
CO₂ savings/Year
43.560 kg
Calculation basis savings: 11l diesel/h - 6 h/day - 250 days/year

Warehouse and logistics operation

COMPACT AND ERGONOMIC

The T-series vehicles are perfectly tailored for extensive use by municipalities, last-mile delivery services, for companies with internal transport routes, nurseries, catering services, logistic centers and many more.

Due to the approval class N1 with a maximum permissible total weight of up to up to 3.5t, the vehicles can be driven with a class B driver's license. The ELION transporters combine a high loading volume with a compact construction. Furthermore, the vehicles convince with a high payload of up to 1.4 t.



COMPACT & MANEUVERABLE

The compact dimensions of the ELION are perfectly suited for working in urban environments. Drive on sidewalks or narrow alleys, due to the narrow track width and narrow clearance width of 1480 mm. You can also benefit from the maneuverability of the ELION vehicles due to the short wheelbase and the installation of the cabin above the front axle without protruding far.

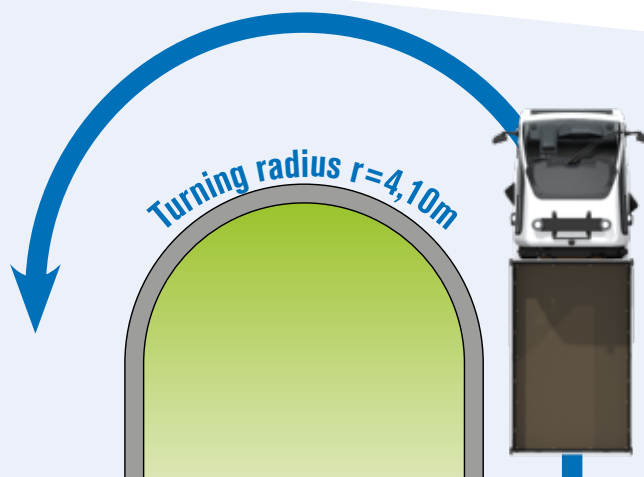



The cabin offers the best protection for driver and co-driver and has been checked and tested in all relevant crash tests of the commercial vehicle class N1.

Facultative, the cabin can also be equipped with a fire extinguisher.



1385mm

CABIN

The command center of the ELION is very comfortably furnished. Seats, instrumentation and displays are ergonomically arranged and designed for a long working day. In direction of travel, the driver's display provides an overview of all the data relevant for driving.

The cabin is designed for two people, with enough space for both driver and co-driver. For logistical services the co-driver seat can be omitted in order to retrofit a logistics interface.

The cabin features a large, tinted panoramic windshield with a good view of the traffic area.

-
- Comfortable cabin with sliding side windows for driver and co-driver
- Very spacious and plenty of headroom, even for tall and stout people
- LED driving lights
- Heated windshield
- Electrically adjustable and heated side mirrors
- Seats with seat heating, adjustable backrest and longitudinal position and continuously height-adjustable armrest (optional)
- Storage spaces and compartments with nets (optional)
- Cup holder
- Heating register with 3-stage and adjustable air vents
- Radio with speakers in the roof liner



INTELLIGENCE THROUGH MLINK

Take advantage of the benefits of MLink Smart.

Network the vehicles with your fleet management system or use the online platform from MUP technologies for evaluation.

Track the position of your vehicles or send orders to the responsible drivers. Keep track of the maintenance intervals of the individual vehicles and the condition of the battery packs via the MLink platform.

VERSATILE & WELL THOUGHT OUT

INDEPENDENT SUSPENSION

The ELION has independent suspension on the front and rear axles. Due to the independent suspension, ELION has a suspension comfort almost like a passenger car. The independent suspension is ideal at higher speeds. It guarantees precise steering and high driving stability.

VEHICLE FRAME

The vehicle frame is a robust steel profile frame partially welded and bolted. For the vehicle frame, the highest quality is used with exclusively S355 steel, as well as KTL and powder coating for the best possible corrosion protection. The vehicle frame has all the necessary mounting points for interchangeable bodies and/or loading areas.

STEPLESS ALL-WHEEL DRIVE

The continuously variable all-wheel drive ensures variable power distribution between the front and rear axles and optimum power adjustment depending on the ground conditions. This all-wheel drive also helps to protect the ground on soft surfaces. Furthermore, it guarantees maximum towing capacity of the work vehicle.



MAINTENANCE:

The T-series electric powered vehicles are not maintenance-intensive.

Locations that require frequent maintenance are easily accessible and panels can be easily removed when necessary.

Most maintenance points can be easily accessed by folding up the body platform.

EQUIPMENT DETAILS



TRAILER COUPLING

The trailer coupling attached to the vehicle in ball head design in combination with the 13-pin plug is designed for trailers with a total weight of up to 1400 kg.



LUGGAGE NETS

Luggage nets in front of and behind the seats provide space for things needed in everyday work.



SWITCH STRIP

The switch strip integrated in the roof liner allows the most important functions, such as the rotating light or repeat lighting, to be operated quickly and conveniently.

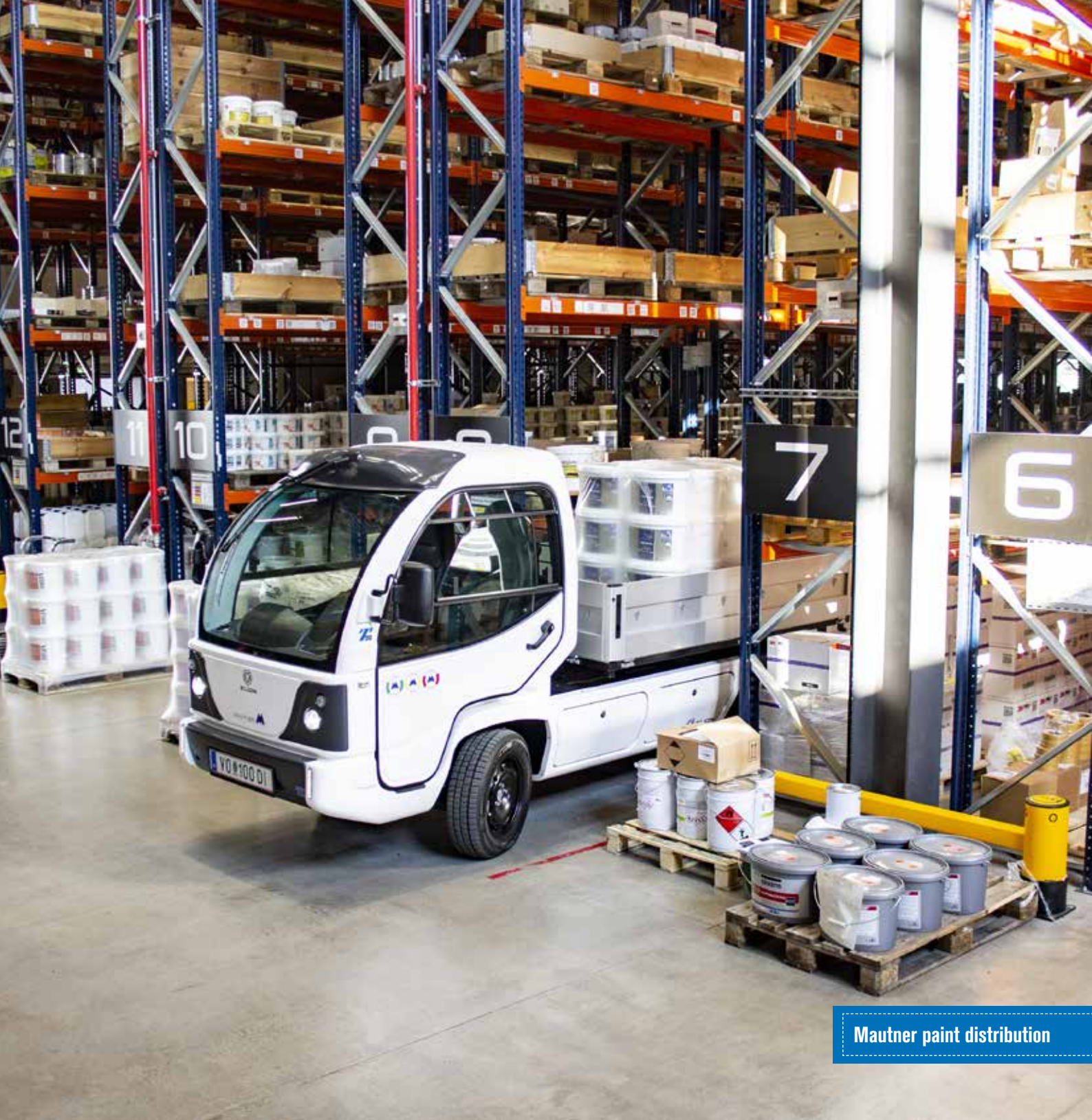

Mautner paint distribution



STORAGE ROOMS

ELION offers three large, externally accessible, waterproof, lockable, storage compartments for work materials, tools or other items.



WARNING LIGHT BAR

The LED warning light bar is easy to install and is characterized by its long service life with constant luminosity.



QUICK-CHANGE SYSTEM

The quick-change system enables safe and convenient changing of different superstructures in the shortest time possible.

UNIVERSAL - ONE VEHICLE - ALL POSSIBILITIES

APPLICATION

The base of the T-series is the starting point of limitless application possibilities. Predefined superstructures can be easily changed and extend the usability within the company or community. The standard superstructures are constantly being developed and expanded. Through personalized superstructures, there are no limits to the applications of the T-series.



green care



casting



special operations



wet cleaning



winter service



transport



weed clearance



disposal / recycling



road maintenance



hospitality & tourism



delivery & package service



industry & intralogistics



agriculture



mobile battery storage



flat loading platform

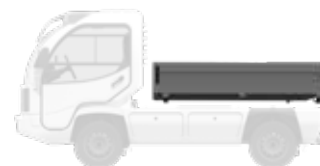

flatbed standard



flatbed with three-way tipper



tarpaulin structure



flatbed with lattice structure



flatbed with ladder holder



short flatbed with box behind cabin

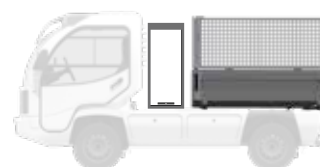

short flatbed with lattice structure and box behind cabin



crane with short flatbed



hook loader

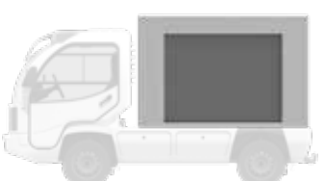

box body



insulated freezer box body

Symbol images, may differ visually

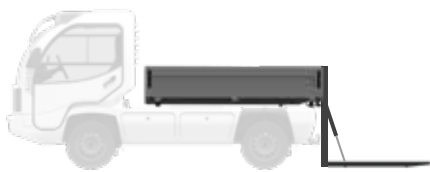

tail lift on flatbed

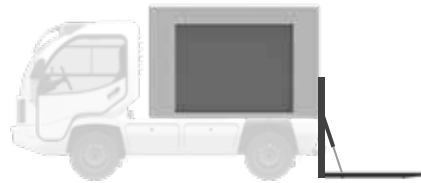

tail lift on box body

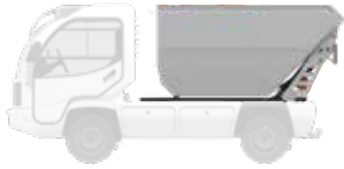

waste transport tub high emptier



waste transport tub high emptier with trash can lift



waste transport tub high emptier with waste can lift and waste compactor



snow blade



flat silo-caster

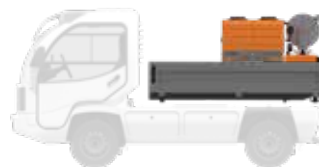

water tank, brine spraying system



trailer coupling front

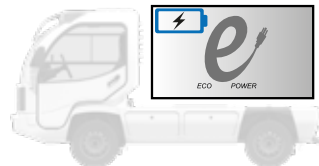

mobile battery storage system by eco power



iDL eHLF Magirus

CAREFREE ENERGY CHARGING

ELION has its charging infrastructure on board, so you can charge your vehicle with energy almost anywhere. You can choose between 230V, 400V or Typ2 charging interfaces, you only need the respective charging cables, which can be delivered with the vehicle.



RANGE*

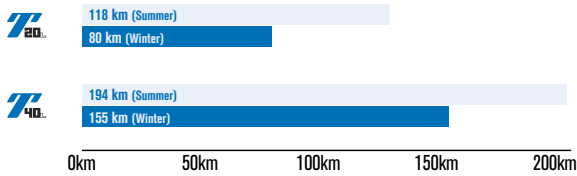

CHARGE TIME (SOC 0-100%)

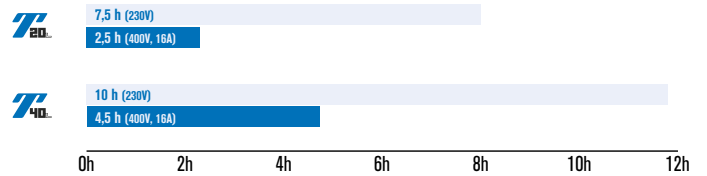

TIRE CAPABILITIES



SUMMER TIRE
185/65R15 | 195/70R15



ALL YEAR TIRE
185/65R15 | 195/70R15



WINTER TIRE
185/65R15 | 195/70R15





ALL TERRAIN & TURF TIRE
195/70R15

COLOR VARIATIONS (SPECIAL COLOR POSSIBLE)

RAL 9010 pure white (Standard)	RAL 3000 fire red	RAL 2011 deep orange
RAL 5015 sky blue	RAL 6018 green	

OVERVIEW VEHICLE TYPES

vehicle type			
drive			
engine power [kW]	15	2x8	2x11
maximum system power [kW]	26	28	51
torque [Nm]	93	135	186
drive type	2WD	4WD	4WD
transmission & driving stages	stepless, transmission with differential 2 driving stages electrically simulated		
pollutant emissions	none		
driving and working characteristics			
speed [km/h]	0-67		
crawling speed [km/h]	0-30		
front axle and rear axle	single-wheel suspension		
steering	electric servo assistance		
brake (Va // Ha)	internally ventilated disc brake // disc brake & load-dependent brake force regulator		
tyres (biggest)	195/70 R15		
cabine	two-person comfort cabin		
charge values			
maximum total weight [kg]	2510	2810	2810
permissible axle load (Va//Ha) [kg]	1270//1240	1420//1390	1420//1390
total pull weight [kg]	3260	3710	4110
max trailer load [kg]	1000	1200	1400
payload [kg] (incl. battery package & driver, without construction)	1114	1374	1285
dimensions (without superstructures)			
wheel base [mm]	2239		
total length [mm]	3967		
total height [mm]	2039 (at 195/70 R15)		
total outside width [mm]	1462 (without mirror) / 1780 (with mirror)		
turning radius [m]	4,10		
ground clearance** [mm]	330		
loading area three-way tipper [mm, L x H x B]	2300x1385x400		
energy storage			
battery chemistry	LiFePO4		LiFePO4
energy content [kWh]	22,0		44,0
range* [km]	118	106	194
charging time 230V [h]	7,5		10
charging time 400V; CEE- 16A [h] (also plug TYP2 possible)	2,5		4,5
charging time 400V; CEE- 32A [h] (also plug TYP2 possible)	k.A.		k.A.
Betriebsspannung [V]	96		

* According to WLTP test (EU) 2017/1151

** with largest tyres

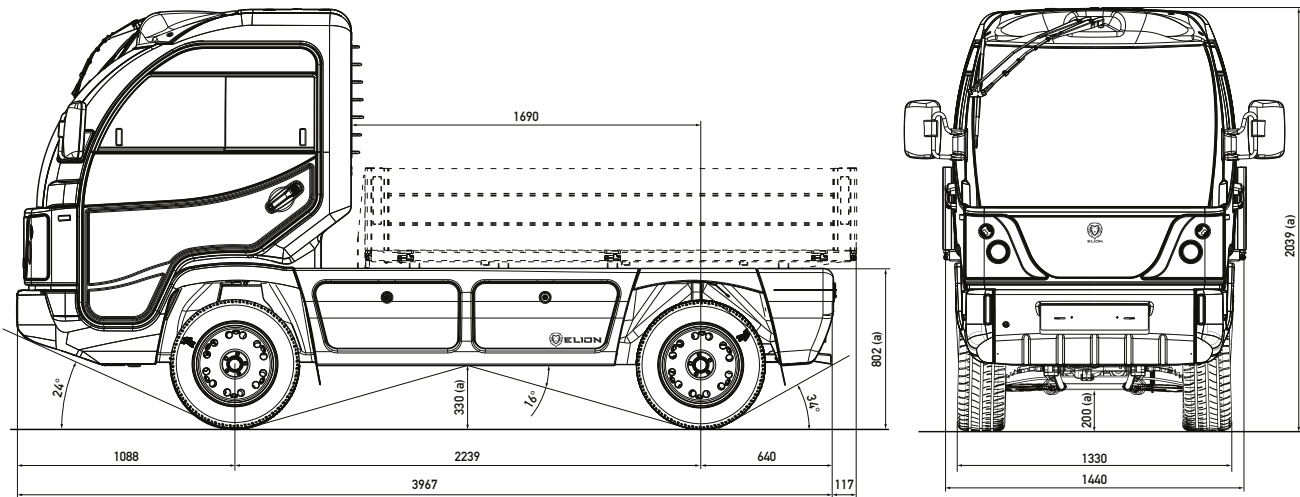

(a) empty vehicle
representation in compressed state, with tyres 195/70 R15



ELION is a brand of Johann Höllwart

THE INFORMATION AND IMAGES IN THIS BROCHURE ARE PROVIDED AS A GUIDE ONLY. MUP TECHNOLOGIES RESERVES THE RIGHT TO MAKE CHANGES AT ANY TIME WITHOUT PRIOR NOTICE FOR COMMERCIAL OR DESIGN REASONS.
VERS.TS.G - 23/01 EN



ADVICE, SALES AND SERVICE FROM YOUR SALES PARTNER

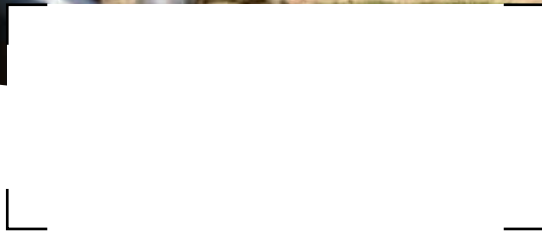

Herberstein Zoo



DIRECT WEB LINK



MUP technologies GmbH
Innovationspark 3, 8152 Stallhofen
T: +43 (0)3142 21244-0
sales@mup-technologies.com | www.elion.net